

ECO1500POT

Product description: WRAS approved cylindrical storage tank, suitable for the storage of drinking water

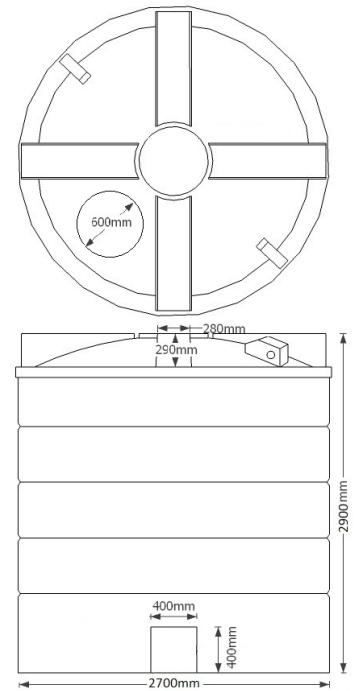

Product Information					
Height	Diameter	Lid	Weight	Outlet	Certificate no:
2900mm	2700mm	24" screwdown	300kg	Supplied loose	2003727

Sizes approximate, owing to shrinkage
Specification subject to change; please call to confirm details

PRODUCT NOTES:

- Tanks must be installed in accordance with The Water Supply (Water Fittings) Regulations 1999 in order to be properly used for storage of drinking water. This will include the addition of fittings which are not supplied with the tank unless ordered separately.
- Tank must be sited on a level, fully supportive base leaving a gap of at least 100mm from walls or other tanks
- Additional fittings can be added as and where required without compromising tank's structural integrity
- Tank moulded blank. Male outlet supplied loose.

PRODUCT DETAILS:

- WRAS approval certificate number: 2003727
- Approximate wall thickness: 6-7mm
- 24" screw down non-vented lid for easy access
- 2" brass threaded male outlet supplied as standard
- Accepts 6" flanged outlets

OPTIONAL EXTRAS:

- Plastic tank connector (up to 4")
- Brass tank connector (up to 3")
- Isolation valve
- By-law kit
- Ball cock and float valve

BENEFITS:

- Suitable for internal and external use
- Frost proof; will not crack in cold
- Plastic meets the requirements of BS 6920-1:2000
- Plastic will not contaminate water
- Value for money, high capacity storage
- Ideal for agricultural or commercial water storage
- Robust, heavy duty product; industrial strength
- Opaque plastic reduces algae growth in sunlight
- Rotationally moulded for strength and durability
- 10 year warranty against manufacturing defects



Etills Ltd,
Unit 1 Whiting Way,
Melbourn,
Royston,
SG8 6NA

Call 01763 261781