

ECO2000BLK

Product description: cylindrical storage tank, suitable for internal or external use

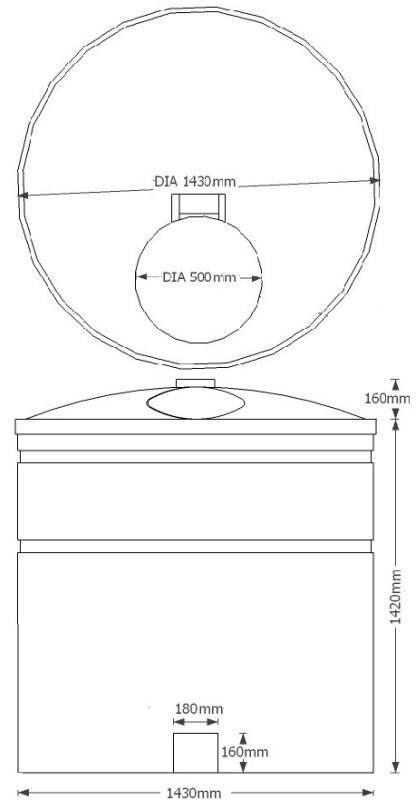
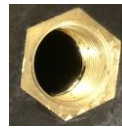

Product Information

Height	Diameter	Lid	Weight	Outlet
1580mm	1430mm	500mm hinged	55kg	2" BSP

Sizes approximate, owing to shrinkage
Specification subject to change; please call to confirm details

PRODUCT NOTES:

- Tank must be sited on a level, fully supportive base leaving a gap of at least 50mm from walls or other tanks
- Additional fittings can be added as and where required without compromising tank's structural integrity
- Outlet not drilled unless requested

PRODUCT DETAILS:

- Made from virgin polymer
- Approximate wall thickness: 5-6mm
- 500mm hinged lid as standard
- 2" brass threaded outlet moulded into the tank

BENEFITS:

- Suitable for internal and external use
- Frost proof; will not crack in cold
- Value for money, high capacity storage
- Ideal for domestic or commercial water storage
- Robust, heavy duty product; industrial strength
- Opaque plastic reduces algae growth in sunlight
- Rotationally moulded for strength and durability
- 10 year warranty against manufacturing defects

OPTIONAL EXTRAS:

- 14" or 16" screw-down lid
- 1" threaded outlet, or moulded blank (no outlet)
- Brass tap
- Brass isolation valve with hose connector
- Tank connectors
- Ball cock and float valve
- Hasp and staple for hinged lid
- Stainless steel outlet



Scan to view our full range
of water tanks



Etills Ltd,
Unit 1 Whiting Way,
Melbourn,
Royston,
SG8 6NA



Call 01763 261781